



Zipabox

QUICK INSTALLATION GUIDE

v.1.1

Copyright

© 2012 Tri plus grupa d.o.o. All Rights Reserved.

Copyright by Tri plus grupa d.o.o.. No part of this manual may be reproduced or transmitted in any form without the expressed, written permission of Tri plus grupa d.o.o.

Trademarks

Zipato and the Zipato logo are registered Trademarks All other product names mentioned herein may be trademarks or registered trademarks of their respective companies.

Notice

Although Zipato has attempted to ensure the accuracy of the content of this manual, it is possible that this document may contain technical inaccuracies, typographical, or other errors. Zipato assumes no liability for any error in this publication, and for damages, whether direct, indirect, incidental, and consequential or otherwise, that may result from such error, including, but not limited to loss of data or profits. Zipato provides this publication “as is” without warranty of any kind, either express or implied, including, but not limited to implied warranties of merchantability or fitness for a particular purpose. The published information in the manual is subject to change without notice.

Zipato reserves the right to make changes in the product design, layout, and driver revisions without notification to its users.

This version of the Installation guide supersedes all previous versions.

Important Safety Information

To avoid contact with electrical current:

- Never install an Ethernet connection in wet locations unless that connector is specifically designed for wet locations.
- Do not place Ethernet wiring or connections in any conduit, outlet or junction box containing electrical wiring.
- Installation of inside wire may bring you close to electrical wire, conduit, terminals and other electrical facilities. Extreme caution must be used to avoid electrical shock from such facilities. Avoid contact with all such facilities.
- Ethernet wiring must be at least 2 m from bare power wiring or lightning rods and associated wires, and at least 15 cm from other wire (antenna wires, doorbell wires, wires from transformers to neon signs), steam or hot water pipes, and heating ducts.

Electromagnetic compatibility

In proper state and when operated properly, the product complies with all the requirements in respect of interference radiation according to EN 301 489-17, EN 301 489-1 and EN 300 328. The connections conducting HF signals must neither be manipulated nor damaged.

Table of Contents

| | |
|---|----|
| INTRODUCTION | 5 |
| CONTENTS OF PACKAGE | 13 |
| CONNECT THE ZIPABOX..... | 14 |
| CREATE A USER ACCOUNT AND REGISTER YOUR SYSTEM..... | 17 |
| INSTALLATION/MOUNTING ZIPABOX..... | 22 |
| ADDING DEVICES | 25 |
| REMOVING DEVICES..... | 26 |
| TROUBLESHOOTING..... | 27 |
| SPECIFICATIONS..... | 32 |
| LIMITED PRODUCT WARRANTY | 33 |
| DECLARATION OF CONFORMITY..... | 38 |
| DISPOSING AND RECYCLING YOUR PRODUCT | 39 |

INTRODUCTION

Thank you for purchasing Zipabox smart home automation controller. This guide describes how to install, program and operate your Zipabox. Zipabox makes every home smart by using advanced technology to hide the complexity of home networking - delivering a simple smart home. It plugs into any outlet in the home and automatically talks to all the connected devices in the house, connecting them to the cloud so that consumers can control them using tablets, smart phones, computers or TVs— at home or on the go.

The Zipabox Gateway supports variety of communication standards including Z-WAVE, ZIGBEE, KNX, ONVIF, and UPnP.

The Zipabox's capabilities can easily be expanded using “snap-in” expansion modules that will add support for new interfaces and functionalities, communication standards and protocols, etc.

Once configured, the gateway works stand-alone, but also features cloud support for advanced monitoring, messaging and programming services.

Intuitive graphical user interface allows customers to program their own home rules without any previous programming experience.

Security and safety

- unlimited number of virtual alarms (partitions)
- up to 233 two-way, wireless zones
- trigger alarms in case of:
 - intruder (motion sensors and door/window sensors),
 - fire (smoke sensors),
 - flood (water leakage sensors),
 - gas (CO sensors)
 - panic button,
 - duress (if someone force you to disarm your system)
 - health care (in case of missing actions during particular time e.g. motion, door opening, laying on bed...)
- remote arm/disarm and status-info with any smartphone
- vandal proof - Zipabox is 24/7 monitored by central station which triggers alarm in case of connection loss
- include arm/disarm commands in automation scenes and rules

- integration with existing alarm systems (DSC, Honeywell...)
- easy online setup and configuration through web based interface
- use of same sensors for security and automation purposes

Lighting

- easy installation of wireless modules
- Z-Wave and ZigBee lighting modules pre-configured for even easier setup
- support remote dimming and on/off switching with any smartphone
- automatically turn lights on at sunset and off at sunrise
- unlimited number of scenes supported
- turn lights on during emergencies
- advanced event based rules configuration
- auto-pilot lighting programs to discourage intruders while home is empty

Climate

- multi-room heating and cooling control with any smartphone
- advanced programming scheduler online, accessible over web browser
- easily create unlimited number of custom zones (thermostats)
- multi-zone humidity control by using standard humidifiers and dehumidifiers
- use Internet weather feeds to program your home climate conditions
- create advanced event based rules to automate home climate based on other environmental and home events
- include climate control in automation scenes together with alarm, lighting, shades, etc
- Notification and automated actions in case of over-temperature events, power outages, and other incidents...

Sun shading

- control blinds, roller-shutters, curtains and pergolas using any smartphone
- automate motors by using fun and easy programming tool online

- add your sun shading commands into home scenarios together with lights, climate, alarms...
- automate your shades to react to outside weather conditions
- easy installation using pre-configured wireless modules

Irrigation

- control unlimited number of irrigation zones
- use advanced programming options online to setup perfect irrigation process
- automate irrigation system based on Internet weather forecast
- integrate your irrigation scheme together with your complete home automation scenarios

Access

- remotely lock/unlock your door with any smartphone
- remotely open/close your garage door or gate over any smartphone
- get video notification when door is open
- use RFID tags to open doors and get detailed statistics about exits/entries

- automate doors/locks using scenarios and event based programming tool
- trigger automation events when door lock user codes are entered
- automatically unlock doors in the event of an emergency

Multimedia

- remotely control your audio/video equipment with any smartphone
- automatically turn on favorite shows when they air and get alerts
- automatically turn off A/V equipment at pre-set time or when room is unoccupied
- automatically turn on equipment to discourage intruders

Video monitoring

- access live and recorded video via the web and from any smartphone
- support for most of the available IP cameras – ONVIF support

- get email and SMS notifications with pictures and live video attached
- remotely adjust pan-tilt cameras
- create advanced event based recording and video notification rules

Energy Metering

- real-time monitoring energy consumption and notification right on smartphone
- compare energy usage and cost with others in the area
- automatically turn on/off your appliances in accordance with electricity prices
- see detailed analysis of your energy consumption
- save energy by automating lights, thermostats, sun shades...

Take care of your safety

Display extreme caution when using ladders or steps, please follow manufacturer's instructions. Be careful when using hand and power tools and follow the manufacturer's guidelines when using them. Take care that the correct tools are used. Wear goggles or protective clothing where required.

Technical support

Having trouble installing your new product? Zipato's website contains the latest user documentation and software updates for Zipato products and services.

www.zipato.com

Call support: + 385 1 444 444 00
(Mon-Fri) 9.00am-06.00pm

CONTENTS OF PACKAGE

- Zipabox
- User manual



- Power adapter 230V AC to 12V DC



- 868 MHz antenna for Z-wave network



- Ethernet cable



CONNECT THE ZIPABOX

Locate your serial number

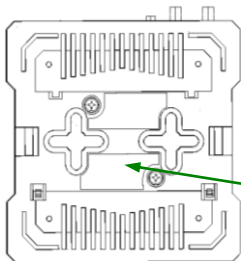

Your Serial number is located on the back of the Zipabox, make a note of it as it will be required when registering your panel online.

**Serial
number**

Connect to broadband

Connect your Zipabox to your broadband router via the Ethernet cable. The Ethernet port is located on the back of the Zipabox

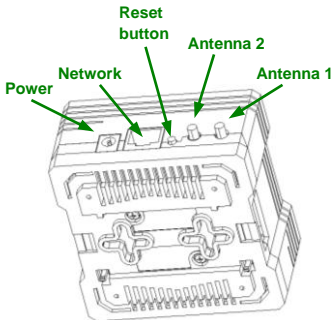

Mount antenna

Screw Z-wave antenna to Antenna1 connector

Power up

Plug the power adaptor into mains supply wall socket and the other end into control unit.

You should see following LED sequence:

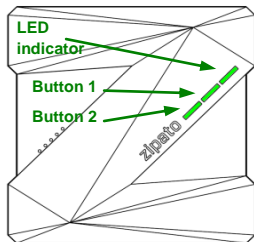

1. Plug in power adaptor: steady **yellow** light for approximately 30 sec.
2. Zipabox getting ready: slowly **flashing green** light
3. Zipabox ready: steady **green** light

CREATE A USER ACCOUNT AND REGISTER YOUR SYSTEM

Account creation

To benefit from the Zipato monitoring and control service you will need to set up your Zipato account and register your Zipabox. Upon registration you will automatically get the basic free level of monitoring service.

Open a browser window on your PC and go to the following URL:

my.zipato.com

Click on “**Register**” button in upper right corner of a screen and follow the onscreen instructions. Next window will pop up.

Create account

Your details

First name:

Last name:

Email:

Password

Password:

Confirm pass:

- Fill out empty fields
- Click on **“Register”**
- Take note of your password during this process.
-

Once you input registration data and click on register, window will pop up with a message:

Success

Congratulations!
Your registration was successful.
Please check you e-mail account.
An e-mail has been sent to the address provided during registration with directions on how to log in to your Zipato account.

When this message appears check your email account. If there is no email please check spam container.

Email should look like this:

Hi „*your email here*“, welcome to the Zipabox!

To validate your email address please click on the following link [verify](#)

Once email is verified, login to Zipato by filling out credentials.

User login

Username:

Password:

Register your Zipabox

When you first time log in to your account, you need to enter serial number of your Zipabox. Serial number is located on back of an Zipabox.

A screenshot of a web form titled "Enter zipato serial". The form contains a label "Zipato serial:" followed by a text input field. Below the input field is a "Save" button.

- Input serial number located at back of an Zipabox

- Serial number must be entered within 2 min. If not, message will appear saying “Allowed registration time elapsed”. This is done because security precaution. If this happens restart Zipabox and reenter serial number

Finalize your account

Your account is set up and you are able to use Zipato cloud system. Anyway, you need to ensure that your account is fully set up so you get the most from your Zipato account.

This includes:

Account Details

Make sure that you have fully completed your profile. Go to **General settings** in the General widget and select **Details tab**.

Users

The Users section is where you add your family members which will have the rights to use your system. Adding new user requires you to enter new user's details and to give him/her certain rights. Rights management allows you to permit some services for some users.

INSTALLATION/MOUNTING ZIPABOX

Zipato provide three methods of mounting.

Wall mounting

Drill holes in the wall surface and insert the wall plugs if fixing into plaster or brick holes. Drill two holes, fix the screws and hook the Zipabox onto the screw's heads. Make sure swivel antenna is in vertical position.

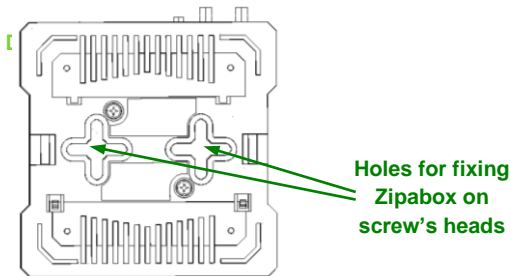

Din rail mounting

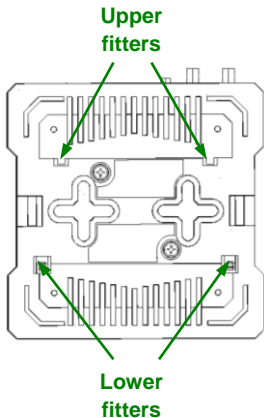

Make enough space for Zipabox on your Din-rail. Hook upper fitters on the back of your Zipabox to the Din rail and press Zipabox slightly to snap lower fitters.

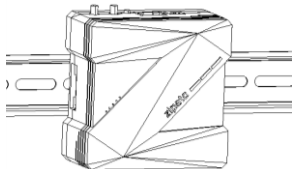
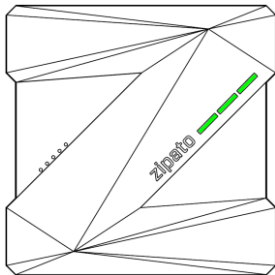

Table top

You can place your Zipabox on any table top. Just make sure that swivel antenna is in vertical position.



ADDING DEVICES

Adding new devices Z-wave or ZigBee

Before adding new device some preparation is needed to ensure successful connection to Zipabox. First **insert batteries** to device or connect it to the power supply. It is recommended to bring device closer to Zipabox so no obstacle can interfere with operating range of device. Recommended **distance between sensor** and Zipabox should be **less than one meter** Read device instruction regarding inclusion/join mode. Device in inclusion/join mode is awake and ready for joining in to Zipato network. In case that device has already been used and connected to controller, **reset device**. Reset deletes any information about prior controller that was stored in device.

At the end of joining or removing session it is recommended to **refresh Zipato Control Center** or wait until number of device isn't increased by one to make sure that device is visible in Total device list.

1. On Zipato dashboard, click “**Add device**” button in General widget and follow wizard instructions. For Z-wave devices, it is recommended that you reset you device before adding it to the Zipato network.
2. After you successfully add the device in to your Zipato network go to “**Total devices**” in General widget and set your device’s room name and type. This will help you to control your device easier.

REMOVING DEVICES

Remove device

To remove device go to Zipato Control Center and click on “**Remove device**” and follow wizard instructions.

TROUBLESHOTING

Waiting for more than a five minutes and still there is no green LED light.

1. Check your Internet connection
2. Check whether you connected your network cable correctly to your Internet router.

I forgot my password

1. Go to **my.zipato.com**
2. Click “Forgot password” and follow screen instruction.

I can't connect any Z-wave or Zigbee device to my box

Check whether your antenna supplied with Zipabox is correctly mounted on Antenna 1 connector.

No Ethernet signal from Zipabox

Before connecting Zipabox check your internet connection. If everything is alright with your internet connection then follow these steps:

1. Unplug power and Ethernet cable from your Zipabox
2. Wait 2 min.
3. First plug in Ethernet cable and then power supply.
4. Press and hold Button2 on your Zipabox and then briefly press (and release) Reset button.
5. Keep holding Button2 for 5 seconds (and then release it).
6. Then observe your LED sequence. If everything goes alright at the end there should be fixed green light from LED.

If this won't work it is obviously a hardware problem. In that case you should return your box to your supplier and take the new one...

I have placed a device outside my house and it is not communicating with the Zipabox. What's happening?

If you have a lot of metal in the exterior construction of your home, this could significantly impede wireless communication. Metal is an insulator of radio signals. If your house has metal siding or a stucco finish over a metal mesh, you may have range problems on devices outside your home communicating with the Zipabox inside.

What should I do if I am having trouble installing my device?

If you are having difficulty with the physical installation of non-Zipato branded devices (Thermostats, GE switches, Blueline meter reader, etc.), please contact the manufacturer directly for assistance.

If you are having trouble pairing a device to the Zipabox, check the videos or other content on Zipato website for assistance.

Error “Validation time expired”

Serial number must be entered within 2 min. If not, message will appear saying “Allowed registration time elapsed”. This is done because security precaution. Allowed registration time starts ticking away after Zipabox establishes connection with the cloud server after power up/reset. So just reset your Zipabox, wait for the light to turn steady green, and the login into the cloud application and enter the serial number.

I have added device to Zipabox, but is not working properly?

If your device isn't working properly try to reinstall it again. Make sure when adding new device that join procedure is completed. If join procedure is successful you will get message “Device joined” and Close button will appear.

What happens when adding new device is interrupted?

If device shows up in total devices window, delete it and then add this device again. If that device isn't shown in total devices window just add this device again.

Don't forget to Synchronies

When doing changes with your device like changing endpoint name, configuration or any change regarding devices and their endpoints, remember to click on synchronize.

Does Zipato offer a warranty?

See the Limited Product Warranty for specifics of the Zipato service warranty.

SPECIFICATIONS

System

ARM9 208MHz CPU
32MB RAM
128MB Flash

Network

Ethernet
Z-Wave (US or EU)
ZigBee (802.15.4) (option)

Operating System

Linux 2.6 Kernel

Power

Power input: 9-12VDC
Power supply input: 100-240VAC,
50/60Hz
Power usage: Idle: 1.2W, Max:
2.4W

Physical Dimension

86 (L) x 8 (W) x 4 (H) millimeters
34in(L)x34(W)x19(H) inches

I/O & LEDs

2 programmable buttons
2 programmable green LEDs
1 programmable RGB LEDs
Power, Status, Ethernet, WLAN &
Z-Wave

Accessories

CAT5e UTP patch LAN Cable
Antenna Z-wave
Antenna Zigbee (option)

Regulatory Compliance (pending)

Safety: UL
EMC: FCC, CE
RoHS

Automation option

Remote automation software
Online remote control interface

Environmental

Temperature Range:
Operating: 0°C to 40°C (32°F to
104°F)
Storage: -25°C to 70°C (-13°F to
158°F)
Humidity: 5% to 95% non-
condensing

Warranty

1 year standard

Specifications are subject to
change without prior notice

LIMITED PRODUCT WARRANTY

GENERAL TERMS

Nothing in this Limited Product Warranty affects your statutory rights as a consumer.

The Limited Product Warranty set forth below is given by Tri plus grupa d.o.o. (Europe) (herein referred to as "ZIPATO"). This Limited Product Warranty is only effective upon presentation of the proof of purchase. Upon further request by ZIPATO, this warranty card has to be presented, too.

EXCEPT AS EXPRESSLY SET FORTH IN THIS LIMITED WARRANTY, ZIPATO MAKES NO OTHER WARRANTIES, EXPRESS OR IMPLIED, INCLUDING ANY IMPLIED WARRANTIES OF MERCHANTABILITY AND FITNESS FOR A PARTICULAR PURPOSE. ZIPATO EXPRESSLY DISCLAIMS ALL WARRANTIES NOT STATED IN THIS LIMITED WARRANTY. ANY IMPLIED WARRANTIES THAT MAY BE IMPOSED BY LAW ARE LIMITED IN DURATION TO THE LIMITED WARRANTY PERIOD.

TO THE EXTENT ALLOWED BY LOCAL LAW, THE REMEDIES IN THIS WARRANTY STATEMENT ARE CUSTOMER'S SOLE AND EXCLUSIVE REMEDIES AGAINST ZIPATO. THEY DO NOT, HOWEVER, AFFECT OR RESTRICT THE RIGHTS YOU HAVE AGAINST THE BUSINESS YOU BOUGHT A ZIPATO PRODUCT FROM. IN NO EVENT WILL ZIPATO BE LIABLE FOR LOSS OF DATA OR FOR INDIRECT, SPECIAL, INCIDENTAL, CONSEQUENTIAL (INCLUDING LOST PROFIT OR DATA), OR OTHER DAMAGE, WHETHER BASED IN CONTRACT, TORT, OR OTHERWISE. HOWEVER, NOTHING IN THIS AGREEMENT LIMITS ZIPATO'S LIABILITY TO YOU (I) IN THE EVENT OF DEATH OR PERSONAL INJURY TO THE EXTENT RESULTING FROM ZIPATO'S NEGLIGENCE, OR (II) TO THE EXTENT

RESULTING FROM ANY FRAUDULENT MISREPRESENTATION ON THE PART OF ZIPATO, OR (III) TO THE EXTENT ARISING UNDER PART 1 OF THE CONSUMER PROTECTION ACT 1987 OF THE UNITED KINGDOM. SOME STATES OR COUNTRIES DO NOT ALLOW: (1) A DISCLAIMER OF IMPLIED WARRANTIES; (2) A LIMITATION ON HOW LONG AN IMPLIED WARRANTY LASTS OR THE EXCLUSION; OR (3) LIMITATION OF INCIDENTAL OR CONSEQUENTIAL DAMAGES FOR CONSUMER PRODUCTS. IN SUCH STATES OR COUNTRIES, SOME EXCLUSIONS OR LIMITATIONS OF THIS LIMITED WARRANTY MAY NOT APPLY TO YOU. THIS LIMITED WARRANTY GIVES YOU SPECIFIC LEGAL RIGHTS. YOU MAY ALSO HAVE OTHER RIGHTS THAT MAY VARY FROM STATE TO STATE OR FROM COUNTRY TO COUNTRY. YOU ARE ADVISED TO CONSULT APPLICABLE STATE OR COUNTRY LAWS FOR A FULL DETERMINATION OF YOUR RIGHTS.

This Limited Product Warranty applies to ZIPATO branded hardware products (collectively referred to as "ZIPATO Hardware Products") sold by ZIPATO (Europe), its European subsidiaries, affiliates, authorized resellers, or country distributors (collectively referred to as "ZIPATO Resellers") with this Limited Product Warranty. The term "ZIPATO Hardware Product" is limited to the hardware components and all its internal components including firmware. The term "ZIPATO Hardware Product" DOES NOT include any software applications or programs.

GEOGRAPHICAL SCOPE OF THE LIMITED PRODUCT WARRANTY

This Limited Product Warranty is applicable to Hardware Products sold by Zipato Resellers in all countries listed at the beginning of this document under the heading "Countries in which this ZIPATO Limited Product Warranty applies". The Limited Product Warranty will be honored in any country where ZIPATO or its

authorized service providers offer warranty service subject to the terms and conditions set forth in this Limited Product Warranty. However, warranty service availability and response times may vary from country to country and may also be subject to registration requirements.

LIMITATION OF PRODUCT WARRANTY

ZIPATO warrants that the products described below under normal use are free from material defects in materials and workmanship during the Limited Product Warranty Period set forth below ("Limited Product Warranty Period"), if the product is used and serviced in accordance with the user manual and other documentation provided to the purchaser at the time of purchase (or as amended from time to time). ZIPATO does not warrant that the products will operate uninterrupted or error-free or that all deficiencies, errors, defects or non-conformities will be corrected.

This warranty shall not apply to problems resulting from: (a) unauthorized alterations or attachments; (b) negligence, abuse or misuse, including failure to operate the product in accordance with specifications or interface requirements; (c) improper handling; (d) failure of goods or services not obtained from ZIPATO or not subject to a then-effective ZIPATO warranty or maintenance agreement; (e) improper use or storage; or (f) fire, water, acts of God or other catastrophic events. This warranty shall also not apply to any particular product if any ZIPATO serial number has been removed or defaced in any way.

ZIPATO IS NOT RESPONSIBLE FOR DAMAGE THAT OCCURS AS A RESULT OF YOUR FAILURE TO FOLLOW THE INSTRUCTIONS FOR THE ZIPATO HARDWARE PRODUCT.

LIMITED PRODUCT WARRANTY PERIOD

The Limited Product Warranty Period starts on the date of purchase from ZIPATO. Your dated sales or delivery receipt, showing the date of purchase of the product, is your proof of the purchase date. You may be required to provide proof of purchase as a condition of receiving warranty service. You are entitled to warranty service according to the terms and conditions of this document if a repair to your ZIPATO branded hardware is required within the Limited Product Warranty Period. [Other than in respect of products for domestic use (in particular those listed in the first and last boxes in the table below), this Limited Product Warranty extends only to the original end user purchaser of this ZIPATO Hardware Product and is not transferable to anyone who obtains ownership of the ZIPATO Hardware Product from the original end-user purchaser.]

Product Warranty Period Table

| Product Type | Product Warranty Period |
|--------------------|-------------------------|
| Zipabox controller | One (1) year |

IMPORTANT:

The content of "Product Type" listed above is subject to change; please refer to the www.zipato.com for latest update.

PERFORMANCE OF THE LIMITED PRODUCT WARRANTY

If a product defect occurs, ZIPATO's sole obligation shall be to repair or replace any defective Zipato Hardware Product free of charge provided it is returned to an Authorized ZIPATO Service Centre during the Limited Warranty Period. Such repair or replacement will be rendered by ZIPATO at an Authorized ZIPATO

Service Centre. All component parts or hardware products that are replaced under this Limited Product Warranty become the property of ZIPATO. The replacement part or product takes on the remaining Limited Warranty Period of the replaced part or product. The replacement product need not be new or of an identical make, model or part; ZIPATO may in its discretion replace the defective product (or any part thereof) with any reconditioned equivalent (or superior) product in all material respects to the defective product.

WARRANTOR

Tri plus grupa d.o.o.

Banjavciceva 11

10 000 Zagreb

CROATIA Telephone +385 (1) 444 444 00

Facsimilie +44(0)208 955 9001

DECLARATION OF CONFORMITY

The Manufacturer Tri plus grupa d.o.o. hereby declares that the product:

Zipabox Smart home controller 1

In accordance with the following Directive(s): 2006/95/EC The Low Voltage Directive, 89/336/EEC The Electromagnetic Compatibility Directive and 1999/5/EC R&TT EC Directive

is in conformity with the applicable requirements of the following documents:

EN 60950-1:2007+A11:2009+A12:2011

EN 301 489-17 V2.1.1:2010

EN 301 489-3 V1..4.1:2003

EN 301 489-1 V1.8.1:2008

EN 300 328 V1.7.1:2008

EN 50130-4:1977+A1:2000+A2:2004

EN 300 220-1 V2.1.1:2006

EN 300 220-2 V2.1.2:2008

I hereby declare that the equipment named above has been designed to comply with the relevant sections of the above referenced specifications. The unit complies with all applicable Essential Requirements of the Directives.

Person responsible for this declaration:

Dean Janacek, COO

01.09.2012

DISPOSING AND RECYCLING YOUR PRODUCT



This symbol on the product or packaging means that according to local laws and regulations this product should be not be disposed of in the household waste but sent for recycling. Please take it to a collection point designated by your local authorities once it has reached the end of its life, some will accept products for free. By recycling the product and its packaging in this manner you help to conserve the environment and protect human health.

Zipato and the environment

At Zipato, we understand and are committed to reducing any impact our operations and products may have on the environment. To minimize this impact Zipato designs and builds its products to be as environmentally friendly as possible, by using recyclable, low toxic materials in both products and packaging.

www.zipato.com

...we make every home smart.